

Applies to the following models:

Viking M	Prod. No. 2040035
Viking L	Prod. No. 2040034
Viking XL	Prod. No. 2040033

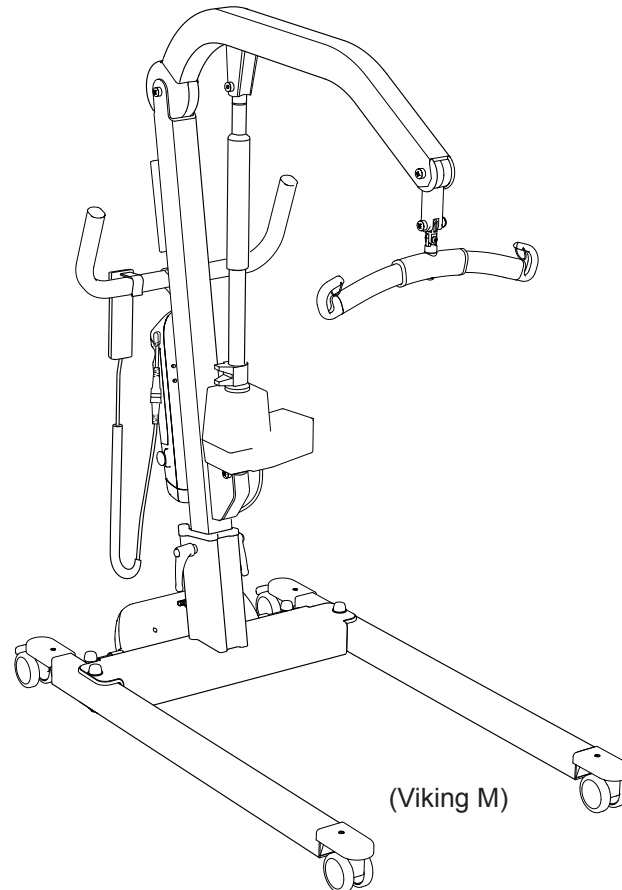

Product Description

Viking M, L and XL are versatile mobile lifts intended mainly for use in health care, intensive care and rehabilitation. Viking M is an general-purpose lift while Viking L and XL are intended for heavier patients.

All three models are excellent aids for daily transfers of adults, bariatrics and children, for instance, lifting to and from wheel chair, bed, toilet and floor. A Viking equipped with armrests can be used for gait training by patients. Horizontal lifting is also possible with any of the Liko stretchers.

Service is facilitated by Liko Diagnostic System™, a monitoring system which continually registers operating data and indicates when the lift is in need of service.

The battery is of environmentally friendly NiMH type.

Individual fitting of the sling and other lifting accessories to the patient is of the utmost importance for optimal performance and safety when using the lift.

In this document, the person being lifted is referred to as the patient, and the person helping them is referred to as the caregiver.

△ is a warning triangle used for situations which require extra care and attention.

 IMPORTANT!

Read the instruction guide for both the patient lift and lifting accessories before use. Lifting and transferring a person always involves a certain level of risk. It is important to completely understand and adhere to the contents of the instruction guides. The equipment should only be used by trained personnel. Please contact your Liko/Hill-Rom representative in the event of any uncertainties or questions.

Table of Contents

Safety Instructions.....	2
Definitions.....	3
Technical Data.....	3
Dimensions.....	4
Assembly.....	4
Operation.....	6
Charging the Batteries.....	8
Maximum Load.....	9
Recommended Lifting Accessories.....	9
Simple Troubleshooting.....	11
Inspection and Maintenance.....	12

△ NOTE!

This instruction guide contains important information for the user of the product.

All who use the product should review and completely understand and adhere to the contents of the instruction guide. Remember to keep the instruction guide in a place where it is always available to those using the product.

Warning!

Certain environments and conditions can limit the correct use of the mobile lifts, including: thresholds, unlevel floor surfaces, various obstacles, and extra-thick carpets. These environments and conditions can cause the wheels of the mobile lift not to roll as intended, possible imbalance in the mobile lift, and increased exertion by the caregiver. If you are uncertain that your care environment fulfills the requirements for correct use of the mobile lift, please contact your Liko/Hill-Rom representative for further advice and assistance.

Safety Instructions

Before using, make sure that:

- the lift is assembled in accordance with the assembly instructions;
- the lifting accessory is properly attached to the lift;
- the batteries have been charged for at least 5 hours;
- you have read the instruction guides for the lift and lifting accessories;
- personnel using the lift are informed of the correct operation and use of the lift.

Before lifting, always make sure that:

- the lifting accessories are not damaged;
- the lifting accessory is correctly attached to the lift;
- the lifting accessory hangs vertically and can move freely;
- the lifting accessory is selected appropriately, in terms of type, size, material and design, with regard to the patient's needs;
- the lifting accessory is correctly and safely applied to the patient in order to prevent injuries;
- the latches are intact; missing or damaged latches must always be replaced;
- the sling's strap loops are correctly connected to the sling bar hooks when the sling straps are stretched up but before the patient is lifted from the underlying surface.

△ Never leave a patient unattended during a lifting situation!



Viking M, L, and XL have been tested by an accredited testing institute and comply with the requirements specified in the Medical Device Directive 93/42/EEC, for Class 1 products.

Viking M, L, and XL comply with the requirements in EN ISO 10535:2006, IEC 60601-1, EN 60601-1-2, ANSI/AAMI ES60601-1, and CAN/CSA C22.2 no 60601-1.

△ The lift must not be modified under any circumstance. If you have any questions, please contact Liko/Hill-Rom.

Particular care must be taken when using powerful sources of electromagnetic disturbance, such as diathermy, etc, so that, for example, diathermy cables are not positioned on or near the lift. If you have any questions, please consult the responsible assistive device technician or the supplier.



The lift may not be used in areas where flammable mixtures may occur, for example, in areas where flammable goods are stored.

Definitions

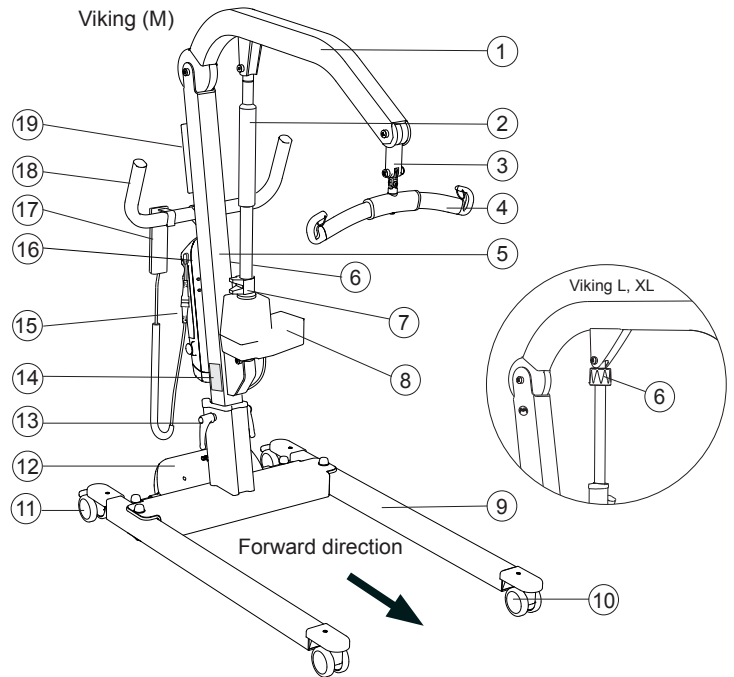
1. Lift arm
2. Outer Tube (Viking M only)
3. Flexlink
4. Sling Bar with latches
5. Lift Mast
6. Control unit IR receiver
7. Emergency Lowering Device (mechanical)
8. Lift Motor
9. Base
10. Front wheels
11. Rear wheels with brakes
12. Motor for base-width adjustment
13. Locking handle
14. Product decal
15. Battery
16. Control box with emergency stop, built-in charger and operation panel (electrical emergency lowering/raising)
17. Hand control
18. Handles
19. Holder for Quick Reference Guide and color code for sling sizes



Technical Data

Maximum load:	Viking M: 205 kg (450 lbs) Viking L: 250 kg (550 lbs) Viking XL: 300 kg (660 lbs)	Sound level:	Viking M : 46 dB(A) Viking L : 51 dB(A) Viking XL : 51 dB(A)
Material:	Aluminium	Protection class:	Viking M : IP 54 Viking L : IP X4 Viking XL : IP X4
Weight:	Total weight: Viking M: 30,2 kg (66.6 lbs) Viking L: 37,4 kg (82.5 lbs) Viking XL: 40,6 kg (89.5 lbs) Heaviest part: Viking M: 15,8 kg (34.8 lbs) Viking L: 21,6 kg (47.6 lbs) Viking XL: 23,6 kg (52.0 lbs)	Operating Forces of Controls:	HandControl: 2.4 N Operation Panel: 4 N
Wheels:	Viking M Front: 75 mm (3 inch.) twin wheels Rear: 75 mm (3 inch.) twin wheels with brakes Viking L, XL Front: 100 mm (4 in) twin wheels. Rear: 125 mm (5 in) twin wheels.	Electrical data:	24 V
Turning diameter	Viking M: 1400 mm (55.2 in) Viking L: 1460 mm (57.4 in) Viking XL: 1570 mm (61.8 in)	Intermittent power:	Int. Op 10/90, active operation max 2 min. Only 10% of a given length of time may be active, but no more than 2 min.
Emergency lowering device:	Mechanical and electrical	Batteries:	NiMH cells, 2.2 Ah. New batteries provided by the supplier.
Lifting interval:	Viking M: 1270 mm (50.0 in) Viking L: 1330 mm (52.4 in) Viking XL: 1370 mm (54.0 in)	Battery charger:	CBL20002, built-in, 100-240 V AC, 50-60 Hz, max 600 mA.
Lifting speed (no load)	Viking M : 42 mm/s and 38 mm/s, respectively Viking L : 21 mm/s and 13 mm/s, respectively Viking XL : 21 mm/s and 13 mm/s, respectively (Viking M: 1.7 in/s and 1.5 in/s, respectively) (Viking L: 0.8 in/s and 0.5 in/s, respectively) (Viking XL: 0.8 in/s and 0.5 in/s, respectively)	Lift motor:	Permanent magnet motor with mechanical safety mechanism Viking M: 24 V, 8.5 A Viking L: 24 V, 6.4 A Viking XL: 24 V, 8.0 A
		Motor for base-width adjustment:	Permanent magnet motor 24 V, 6 A
		 The device is intended for use indoors	
		 Type B, in accordance with the electrical shock protection class.	
		 Class II equipment.	

Dimensions

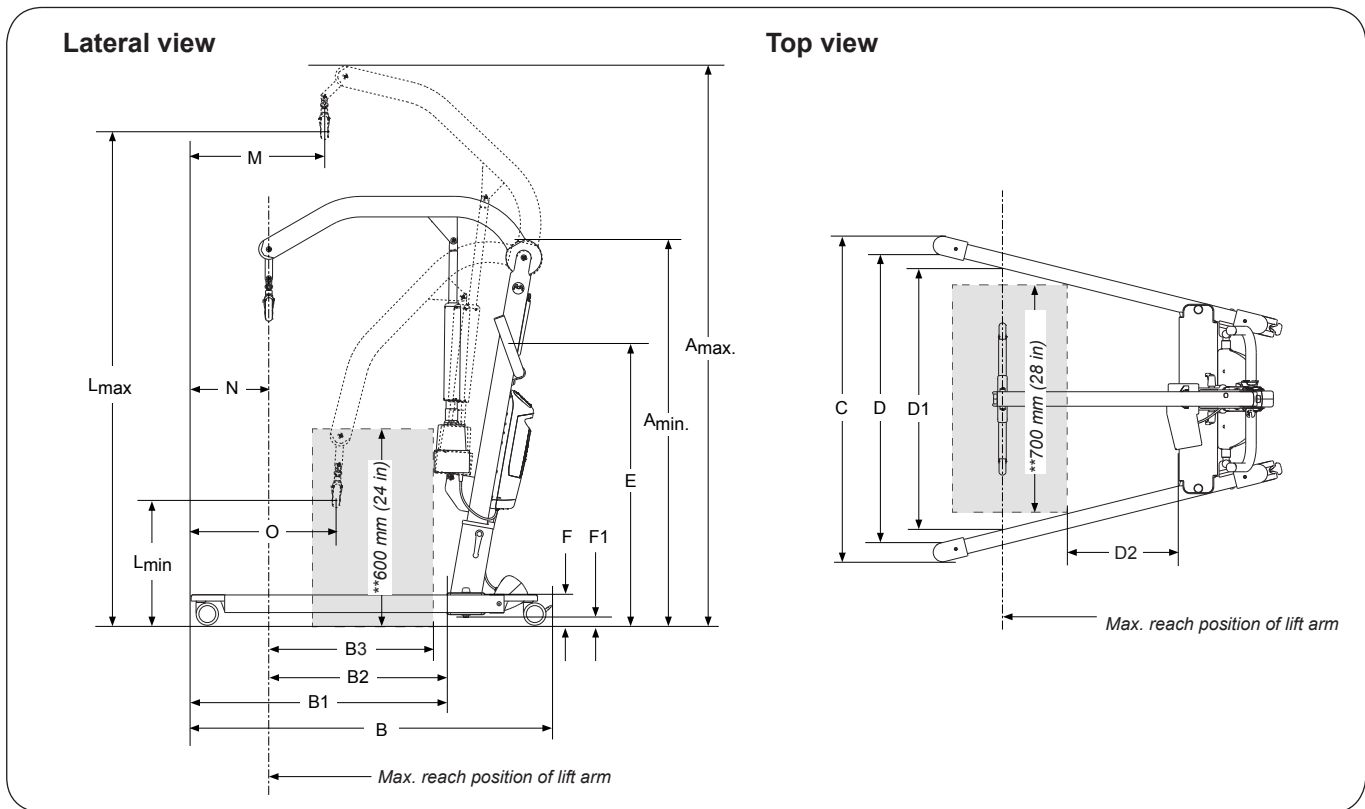

Viking M

Measurements: mm / in

Amax.*	Amin.*	B	B1	B2	B3**	C		D		D2**	E*	F	F1	Lmax*	Lmin*	M	N	O			
						max.	min.	max.	min.												
2020	1440	1230	870	660	650	1110	690	970	560	195	1100	105	30	1790	520	385	220	495			
1970	1390				650														1050	1740	470
1920	1340				595														1000	1690	420
79.5	56.7	48.4	34.3	26.0	25.6	43.3	27.2	38.2	22.0	7.7	43.3	4.2	1.2	70.5	20.5	15.2	8.7	19.5			
77.6	54.7				25.6														41.4	68.5	18.5
75.6	52.8				23.4														39.4	66.5	16.5

Viking L

Measurements: mm / in

Amax	Amin	B	B1	B2	B3**	C		D		D2**	E	F	F1	Lmax	Lmin	M	N	O
						max	min	max	min									
2030	1390	1360	900	630	560	1070	695	950	625	230	1060	165	43	1790	460	500	280	550
80.0	54.7	53.5	35.4	24.8	22.0	42.1	27.4	37.4	24.6	9.1	41.7	6.5	1.7	70.5	18.1	19.7	11.0	21.7

Viking XL

Measurements: mm / in

Amax.	Amin.	B	B1	B2	B3**	C		D		D2**	E	F	F1	Lmax	Lmin	M	N	O
						max.	min.	max.	min.									
2110	1500	1420	960	600	560	1130	815	1015	605	145	1010	170	40	1910	540	557	365	665
83.1	59.1	55.9	37.8	23.6	22.0	44.5	32.1	40.0	23.8	5.7	39.8	6.7	1.6	75.2	21.3	21.9	14.4	26.2

Note: When changing to other lifting accessories check that the lift still achieves desired lifting height.

* Different measurements apply to Viking M depending on the height-setting position, see "Assembly", page 5.

** Reference measurement according to Standard EN ISO 10535:2006.

Assembly

Before assembly, make sure you have the following parts:

- Lift mast with lift arm, holder for Quick Reference Guide, lift motor incl. cable, sling bar and control box with hand control
- Base with motor for base-width adjustment, incl. cable
- Locking handles; Viking M, L (1 set), Viking XL (2 sets)
- Battery
- Bag containing instruction guide, quick reference guide, charger cable, charger connector cable, cable lid with screws (2), Allen wrench.

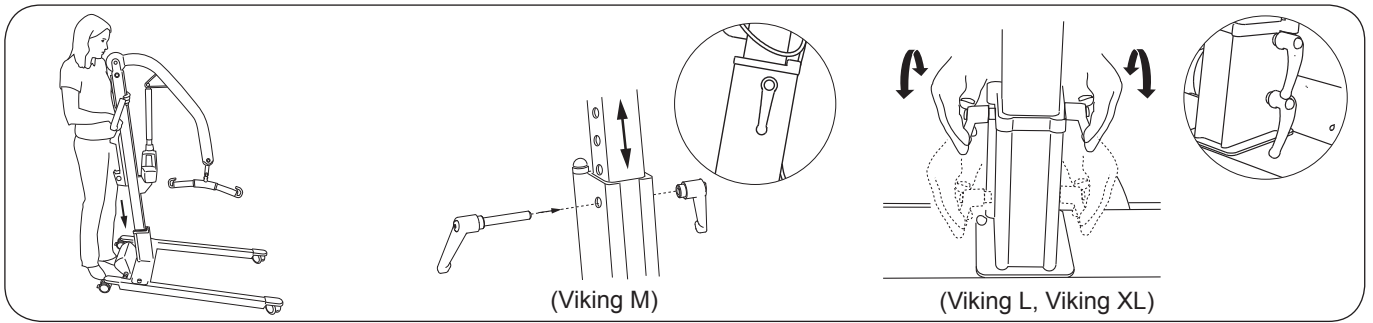

1. Lock both rear wheels. Place the lift mast in the foot of the base.
2. Secure the lift mast in the locking handles provided. Adjust the position of the locking handles so that they point downwards. **NOTE!** Viking M has an adjustable lift mast which can be set to three different levels. The middle hole is recommended in most cases. The lowest hole of the lift mast is recommended for extra high lifting height. The highest hole is recommended for lower lifting heights. The distance between two holes is 50 mm (2 in). See the measurement table, page 4.

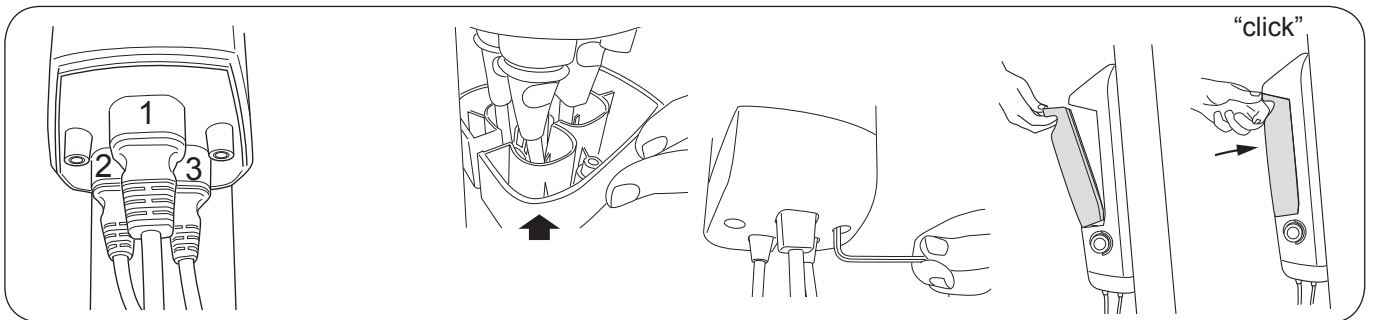

3. Connect the cables as follows:
 - Charger cable to socket 1.
 - Cable from lift motor to socket 2.
 - Cable for motor for base-width adjustment to socket 3.
4. Insert the cables through the opening in the cable lid. Push the lid up and secure with the provided Allen key and screws (2).
5. Place the battery in its bracket in the control box. Check that the battery is secured in its position.

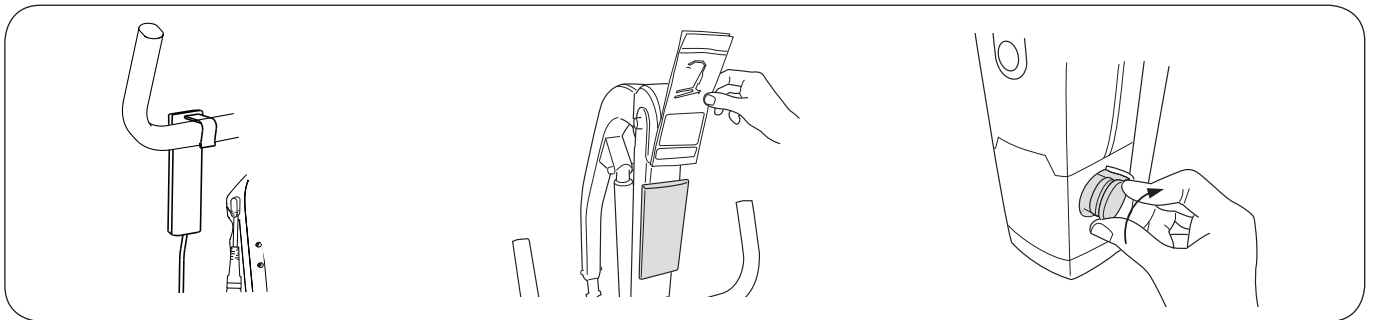

6. Hang the hand control on the handle.
7. Place the quick reference guide in the holder on the lift mast.
8. Release the emergency stop by turning the button in the direction indicated by the arrows on the button.



9. Before initial use, charge the battery by plugging the charger cable into the connector cable. Then plug the charger cable into an electric outlet (100-240 V AC). The lamps on the control box front flash alternatively (green/orange/orange) during the charging. The battery is fully charged after approx. 5 hours.
10. Place the charger cable on the hook provided on the mast after completed charging.

After assembly and charging, ensure that:

- The motion of the lift arm corresponds to the buttons on the hand control/operation panel.
- The emergency lowering functions are working (mechanical and electrical).
- The wheel brakes are working.
- The base-width adjustment works.
- The batteries are charged.

Operation

The lift can be operated with the hand control or from the operation panel.

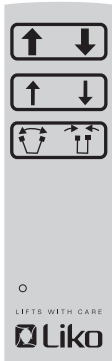

↑ ↓ – **Up / Down**, adjust the lifting motion

↑ ↓ – up / down, (*slowly*)

↔ – **Out / In**, adjust the base width

— Cable



↑ up, (*slowly*)

↓ down, (*slowly*)

↔ Base wider

↔ Base narrower

Hand Control

The direction of the arrows applies when the hand control is held as shown in the picture. The lifting and base movement stops as soon as the push button is released.

Operation Panel

There are 6 push buttons on the panel. For the symbols and indicator lights of the operation panel, please see below.

Symbols and indicator lights (Liko Diagnostic System™) on the operation panel:

IR - communication, (green light)
- Receives/Sends IR signals.

Service indicator (orange light)
- Illuminates when service is needed. Contact the service technician authorized by Liko/Hill-Rom.

Overload (orange light)
- Illuminates if the lift's maximum load is exceeded, and the lift stops. The indicator turns off after 3 secs., and the lift operates again.

Expected Life Time (ELT) (red light)
- When the light flashes during lifting, the Liko Diagnostic System™ indicates that the expected life time for the lift is approaching its end. Contact the service technician authorized by Liko/Hill-Rom.

⚠ If the ELT light proceeds to shine continuously when lifting, the lift should be taken out of service. Contact the service technician authorized by Liko/Hill-Rom.

Activate

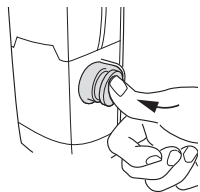

Reset

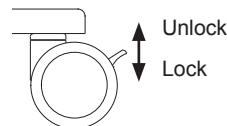
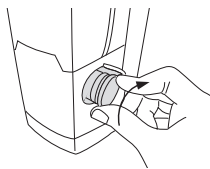

(Viking M)

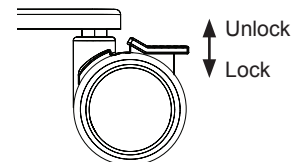

(Viking L, Viking XL)

Emergency stop

Activate:
Press the red button on the control box.

Reset:
Turn the button in the direction indicated by the arrows on the button.

Locking the Wheels

The rear wheels can be locked to prevent rotating and turning. The locking/unlocking of the wheels is done with the foot.

⚠ Locked wheels during lifting can increase the risk of tipping.

NOTE: When lifting, the wheels should be unlocked so that the lift can be moved to the patient's centre of gravity. The wheels should be locked, however, if there is a risk of the lift rolling into the patient, for instance, when lifting from the floor.

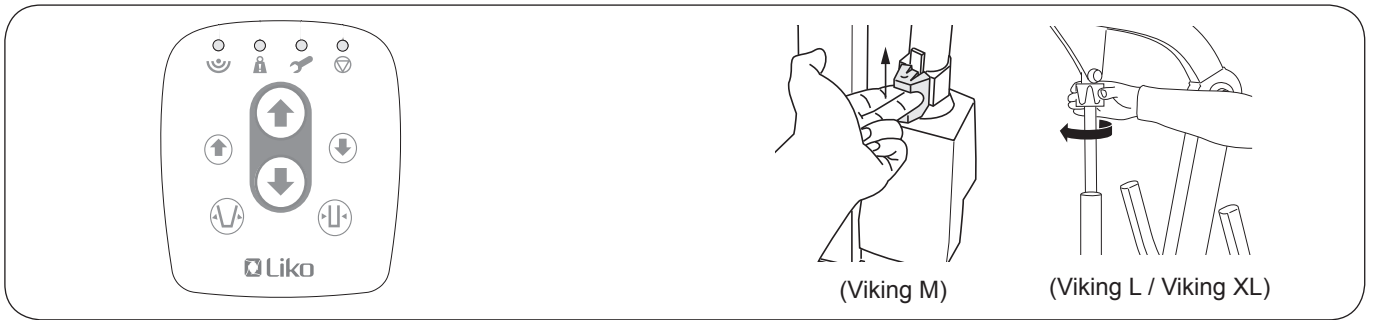

Electrical Emergency Lowering/Raising

Use the arrow buttons on the operation panel (up or down) until the patient being lifted is on a firm surface and the strap loops of the sling can be unhooked.

Mechanical Emergency Lowering

Enabling the emergency lowering on **Viking M**:
 - Lift the emergency lowering control straight up, lift until the patient being lifted is on a firm surface, and the strap loops of the sling can be unhooked. (the function requires a load applied to the lift arm).
 Enabling the emergency lowering on **Viking L and Viking XL**:
 - Turn the emergency lowering control clockwise, repeat the movements until the patient being lifted is on a firm surface and the strap loops of the sling can be unhooked.

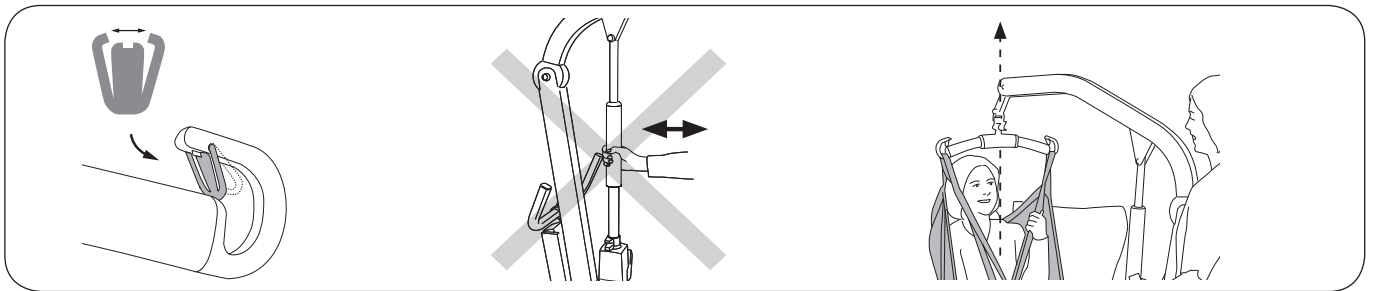

Installation of Latches

After installation, ensure that the spring loaded latches is taut against the sling bar and moves freely in the sling bar hook.

⚠ Never move the lift by pulling on the actuator!

Always Lift Securely

Always lift with the sling bar vertically above the patient's centre of gravity. To obtain this, consider the placement of the lift in relation to the patient. Read the section "Position of the Lift when Lifting", page 7.
 Before each lifting situation, ensure the lifting is performed correctly.
⚠ Unbalanced lifting poses a tipping risk!

Position of the Lift when Lifting

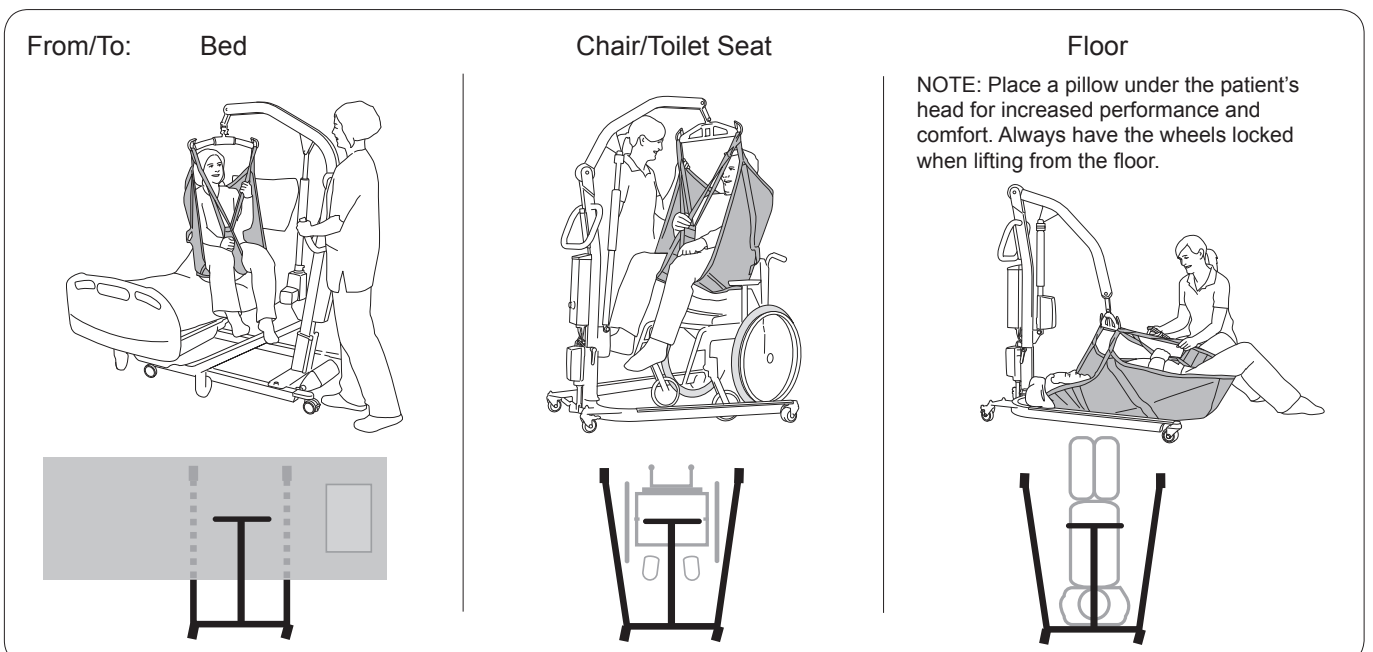

Description of Functions and Operation (Viking XL)

Universal TwinBar 670

Universal TwinBar 670 (prod. no. 3156077) for a maximum load of 300 kg (660 lbs) is included with Viking XL. It is equipped with four hooks. The widest bar is intended for the upper strap loops of the sling and the short bar is for the strap loops of the leg supports. The wide sling bar provides for comfortable space for the upper body of the patient, even when the arms are on the inside of the sling.

△ It is important that all four hooks be loaded when lifting.

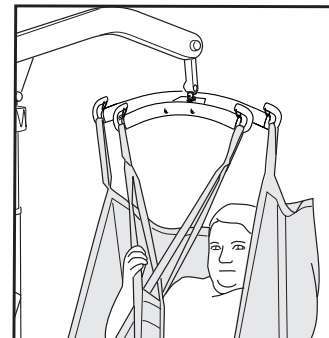

Charging the Batteries

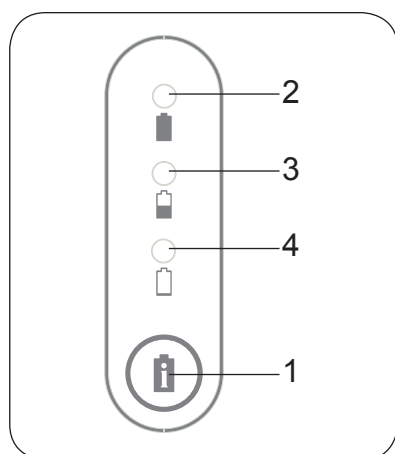

Battery Capacity

Check the battery capacity by pressing the i-button (1). The following information can be read:

2 - Green light: More than 50% of the battery capacity remains.

3 - Orange light: 25–50% of the battery capacity remains.

4 - Orange light: 0–25% of the battery capacity remains.

The indication lamps light up for about half a minute; they then go out. The battery capacity is also shown when the lift is in use.

To obtain maximum service life, it is important to charge the batteries regularly. We recommend charging after use of the lift or every night. Maximum charge is obtained after about 5 hours. When the batteries are fully charged, the charger switches to “trickle charging” automatically.

During charging the lights shine alternatively (orange, orange, green). For deeply discharged batteries, the indication for initiated charging can be delayed a few minutes. Completed charging is indicated by a flashing green light. When the operation time is noticeably shortened, the batteries probably need changing. Stop charging and switch batteries.

The lift cannot be charged with the emergency stop engaged.

Never charge batteries in a wet area.

NOTE! If the lift is not to be used for a long period, the battery should be connected to charging.

Charging

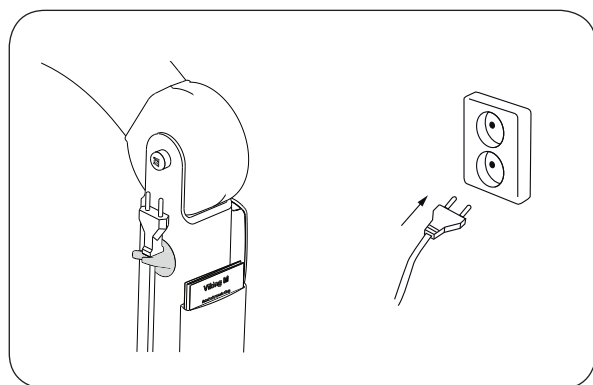

With built-in charger:

Check that the charger cable is connected to the control box outlet; see p. 5.

Connect the charger cable to an electrical outlet (100-240 V AC).

Completed charging is indicated by a flashing green light on the battery.

If the charger cable is permanently stretched, it should be replaced in order to minimize the risk of the cable getting stuck and breaking.

NOTE! The lift cannot be used when the charger cable is plugged into a wall socket.



Old batteries are to be deposited at the nearest recycling station or given to personnel authorized by Liko/Hill-Rom.

Maximum Load

Different maximum loads may apply to different products on the assembled lift unit, sling bar, sling and any other accessories used. For the assembled lift unit, the maximum load is always the lowest maximum load rating for any of the components. For example, a Viking M which is approved for 205 kg (450 lbs) can be equipped with a lifting accessory which is approved for 200 kg (440 lbs). In this case, the maximum load of 200 kg (440 lbs) applies to the assembled lift unit.

Study the markings on the lift and lifting accessories or contact your Liko/Hill-Rom representative if you have any questions.

Recommended Lifting Accessories

△ Using lifting accessories other than those approved can entail a risk.

Generally recommended sling bars and accessories for Viking mobile lifts are described below.

When changing a sling bar or other lifting accessories, the highest possible lifting height of the lift is affected. Before changing lifting accessories you should always ensure that the lift, after change, can fulfil the desired lifting height in order to manage the lifting situations for which the lift is to be used.

To select suitable slings and other lifting accessories, please see the “*Lifting accessories*” brochure. For additional guidance in selecting a sling, study the operating instructions for the respective sling models. There you will also find guidance for combining Liko’s sling bars with Liko’s slings.

Contact your Liko/Hill-Rom representative or visit www.liko.com for advice and information on Liko’s product range.

SlingBar Mini 220
Max. 205 kg (450 lbs)

Prod. No. 3156005

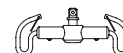

Universal SlingBar 350*
Max. 300 kg (660 lbs)

Prod. No. 3156074

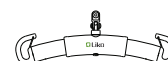

Universal SlingBar 450*
(Standard on Viking M and L)
Max. 300 kg (660 lbs)

Prod. No. 3156075

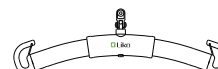

Universal SlingBar 600*
Max. 300 kg (660 lbs)

Prod. No. 3156076

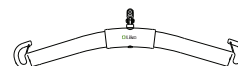

Universal TwinBar 670*
(Standard on Viking XL)
Max. 300 kg (660 lbs)

Prod. No. 3156077

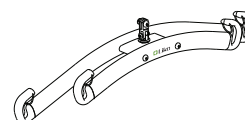

Universal SideBars 450 including bag
Max. 300 kg (660 lbs)

Prod. No. 3156079

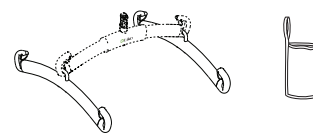

Sling Cross-bar 450*
Max. 300 kg (660 lbs)

Prod. No. 3156021

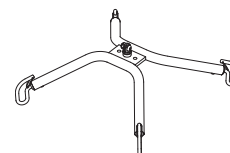

Sling Cross-bar 670*
Max. 300 kg (660 lbs)

Prod. No. 3156018

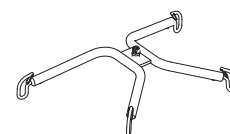

SlingBar Cover Paddy 30
(fits Universal SlingBars 350, 450, and 600, as well as SlingBar Slim 350)

Prod. No. 3607001

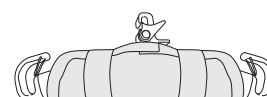

* also available equipped with Quick-Release Hook.



Quick-Release Hook

Liko's Quick-Release Hooks are a system for quick change of lifting accessories on Liko's mobile and stationary lifts. Viking must be equipped with the Q-link 13 in order to be used with the Quick-release Hook.

The Quick-release Hook Universal fits the Universal SlingBar 350, 450 and 600 (prod. no. 3156074 - 3156076). Quick-release Hook TDM fits the SlingBar Mini 220 (prod. no. 3156005), Sling Cross-bar 450 and 670 (prod. no. 3156021 and 3156018) and Universal TwinBar 670 (prod. no. 3156077).

When changing to a sling bar with quick release hook, the lifting height is reduced by 33 mm (1.3 in) in comparison with a fixed sling bar.

Refer to "Guide to Liko's Quick-release Hook System", which can be downloaded from our website www.liko.com, or contact Liko/Hill-Rom for more information.

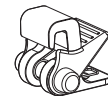

Quick-release Hook Universal
Prod. No. 3156508

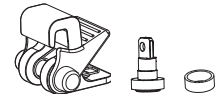

Quick-release Hook TDM
Prod. No. 3156502



Q-link 13
Prod. No. 3156509

Stretchers

Viking M, L, and XL can be used in combination with some Liko Stretchers for horizontal lifting. Contact Liko/Hill-Rom for further information.

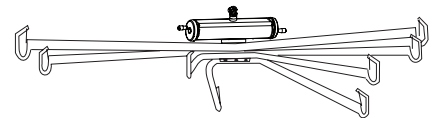

Bag for SlingBars

Prod. No. 2001025



Scale

For weighing patients in combination with Viking, we recommend using LikoScale 350 (adapter 12 mm is required). Max 350 kg (770 lbs).

LikoScale 350 is certified according to the European Directive NAWI 90/384 (Non-Automatic Weighing Instruments).

Contact Liko/Hill-Rom for further information.

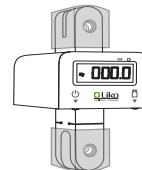

LikoScale 350
Prod. No. 3156228



Adapter 12 mm
Prod. No. 2016504

Viking Armrest M

Prod. No. 2047011

Viking L, XL Armrest

Prod. No. 2047010

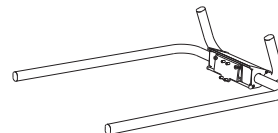

Leg Protector S, M

Prod. No. 2046011

Leg Protector Viking L

Prod. No. 2046012

Leg Protector Viking XL

Prod. No. 2046013

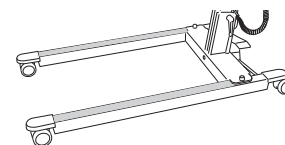

Wall-mounted Battery Charger

Prod. No. 2004111 - 2004114



Battery

Prod. No. 2006107

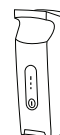

Simple Troubleshooting

The lift doesn't work up/down with Hand Control.

The base-width adjustment doesn't work (in/out) with the Hand Control.



1. Check that the emergency stop button has not been pressed.
2. Check the battery capacity.
3. Check that the charger cable is not connected to an electric outlet.
4. Check that the hand control cable is correctly connected.
5. If the lift works via the operation panel, change the Hand Control.
6. *If the problem persists, please contact Liko/Hill-Rom.*

The lift does not work up/down with the operation panel.

The base-width adjustment doesn't work (in/out) with the operation panel.



1. Check that the emergency stop button has not been pressed.
2. Check that the cables to the control box are connected correctly.
3. Check that the charger cable is not connected to an electric outlet.
4. Check the battery capacity.
5. *If the problem persists, please contact Liko/Hill-Rom.*

The charger doesn't work.



1. Check that the emergency stop button has not been pressed.
2. Check that the charger cables are connected correctly.
3. Make sure that the battery is properly attached.
4. *If the problem persists, please contact Liko/Hill-Rom.*

The lift is stuck in the high position.



1. Check that the emergency stop button has not been pressed.
2. Check the battery capacity.
3. Check that the hand control cable is connected correctly.
4. Electrical emergency lowering, use the operation panel to lower the patient onto a firm surface.
5. Use the mechanical emergency lowering device to lower the patient onto a firm surface.
6. *If the problem persists, please contact Liko/Hill-Rom.*

If you hear unusual sounds.



Contact Liko/Hill-Rom.

Inspection and Maintenance

For trouble-free use, certain details should be checked each day the lift is used:

- Inspect the lift and check to make sure that there is no external damage.
- Check the sling bar attachment.
- Check the functionality of the latches.
- Check the integrity of the lifting motion and the base-width adjustment.
- Check to make sure that the emergency lowering (both electrical and mechanical) works.
- Charge the batteries each day the lift is used and then check that the charger works.

When necessary, clean the lift with a moist cloth and check that the wheels are free from dirt. **NOTE! Do not use cleaning agents containing phenol or chlorine, since these can damage aluminium and polyamide material.**

△ **The lift should not be exposed to running water.**

Service

A periodic inspection of the lift should be carried out at least once per year.

△ **Periodic inspection, repair and maintenance should be performed only in accordance with the Liko Service Manual, and by personnel authorized by Liko/ Hill-Rom and using original Liko spare parts.**

Service Agreement

Liko/ Hill-Rom offers the opportunity to enter into service contracts for the maintenance and regular inspection of your Liko/ Hill-Rom product.

Expected Life Time

The product has an expected service life of 10 years when correctly handled, serviced and periodically inspected in accordance with Liko's instructions.

Transport and Storage

During transport, or if the lift is not to be used for a long time, the Emergency Stop should be engaged. The environment in which the lift is transported and stored should have a temperature of 10–40°C (50–104°F) and a relative humidity of 30–75%. The air pressure should be 700–1060 hPa.

Recycling

For instructions on how to recycle your Liko/ Hill-Rom product, please visit our website: www.liko.com.

Product Changes

Liko products undergo continuous development, which is why we reserve the right to make product changes without prior notice. Contact your Liko/Hill-Rom representative for advice and information about product upgrades.

Design and Quality by Liko in Sweden

Hill-Rom's Management system are certified in accordance with ISO 9001 and its equivalent for the medical device industry, ISO 13485. Hill-Rom's Management system is also certified in accordance with environmental standard ISO 14001.



A  Company

www.liko.com

Manufacturer:

Liko AB
Nedre vägen 100
SE-975 92 Luleå
Sweden
info@liko.se